



# SHELTON AIR COOLED CHILLERS SAE-AC1 with *Hot Gas Bypass*

Designed Cooling Capacity of 2.8 kW

Outlet temperature preset of 7°C

Panasonic Rotary Compressor

Hot Gas Bypass Technology

Stainless steel chilled water pump

Stainless steel plate type evaporator

Built in expansion water tank

Single speed low noise condenser fan

Proudly assembled in Singapore



## COMPRESSOR

- 1 No of Compressor ( DOL – Fixed speed )
  - Panasonic Low Noise Rotary Compressor
  - Power input : 0.89 kW / 4.78 A
- Single refrigerant circuit



## WATER CIRCUIT

- 1 No of Circulation Water Pump
  - Stainless Steel 304 Horizontal Multistage Centrifugal
  - Duty Flow rate : 2.1 US GPM ( 8 L/min )
  - Duty Pressure : 58 PSI ( 4 Bar )
  - Power input : 0.55 kW / 3.65 A
- 16L Stainless Steel Insulated Buffer Water Tank



## AIR COOLED CONDENSER

- Single Speed Axial Fan
  - 400mm Diameter, 920 RPM low noise fan
  - Air flow of 1200 m<sup>3</sup>/hr
  - Power input : 0.11 kW / 0.5 A
- Optimized Copper Tube Aluminum Fin Ambient Air Cooled Condenser



## HEAT EXCHANGER

- Stainless Steel 316 Copper Brazed Plate Type
- Efficient heat transfer with small footprint



## POWER REQUIREMENTS

Incoming Power : 1 PH 220V 50Hz  
Total Input Power : 1.55 kW  
Total Current : 8.93 A  
Recommended Breaker : 13A 3 Pin Plug



## CONFIGURATIONS

Adjustable Temperature Range : 7°C - 35°C  
Capacity Control : 0% / 100% via Hot Gas Bypass  
Inlet Connection : DN15 ( 0.5 Inch )  
Outlet Connection : DN15 ( 0.5 Inch )  
Length : 650 mm  
Width : 550 mm  
Height : 850 mm  
Weight : 100 kg



## SAFETY PROTECTION DEVICES

High Refrigerant Discharge Pressure Switch  
Low Refrigerant Discharge Pressure Switch  
Condenser Overload  
Water Pumps Overload  
Compressor Overload  
Anti Freeze Backup for Primary Sensor  
Pressure Differential Flow Switch  
Automatic over pressure relief valve

<b>Model</b>	<b>SAE-AC1</b>
Refrig. Capacity @ 7°C	2.8 kW 9,000 BTU 2,400 Kcal
Refrig. Capacity @ 15°C	3.9 kW 12,465 BTU 3,324 Kcal
Temperature Range	5°C - 35°C up to -20°C option avail.
Temperature Stability	+/- 0.5°C up to +/- 0.1°C option avail.
Power Requirement	1Ph 200V 50Hz 13A plug 3 Pin
Consumed Power (Total)	1.55 kW 8.93 A
Capacity Control	Hot Gas Bypass
Refrigerant	R22 / R407c
Compressor Type Power Input	1 No of Rotary, Fixed Speed 0.89 kW / 4.78 A
Condenser Fan Type Power Input	1 No of Quiet Axial Fan 0.11 kW / 0.5 A
Water Pump Type Power Input Performance	SS304 Centrifugal Pump 0.55 kW / 3.65A 2.1 US GPM @ 58 PSI ( 7.9 L/min @ 4 Bar )
Reservoir Vol	Insulated Welded Tank of SS304 grade, of 16L capacity
Evaporator	Copper Brazed, with SS316 Plates
Water Inlet / Outlet Connection	DN15 (0.5 Inch)
Dimensions	650 mm (Length) 550 mm (Width) 850 mm (Height)
Weight	73 kG

# CHILLER DIMENSIONAL DRAWING

BACK VIEW

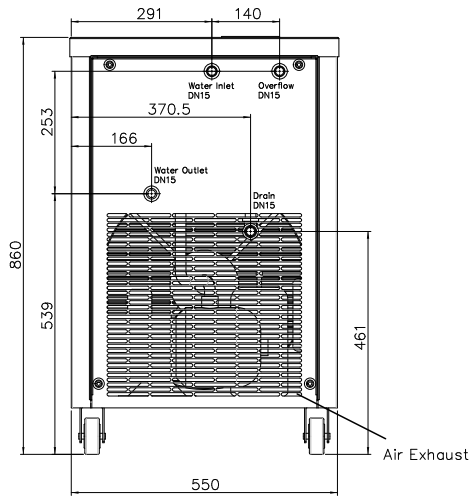

SIDE VIEW

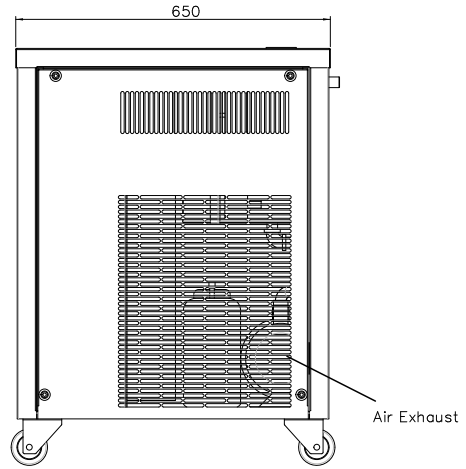

FRONT VIEW

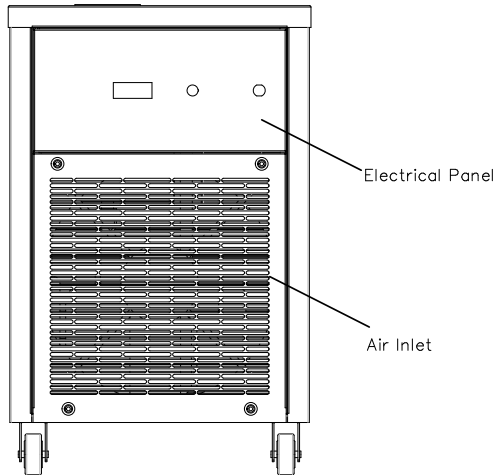



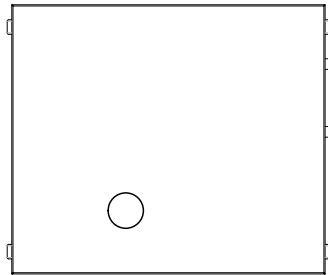

TOP VIEW



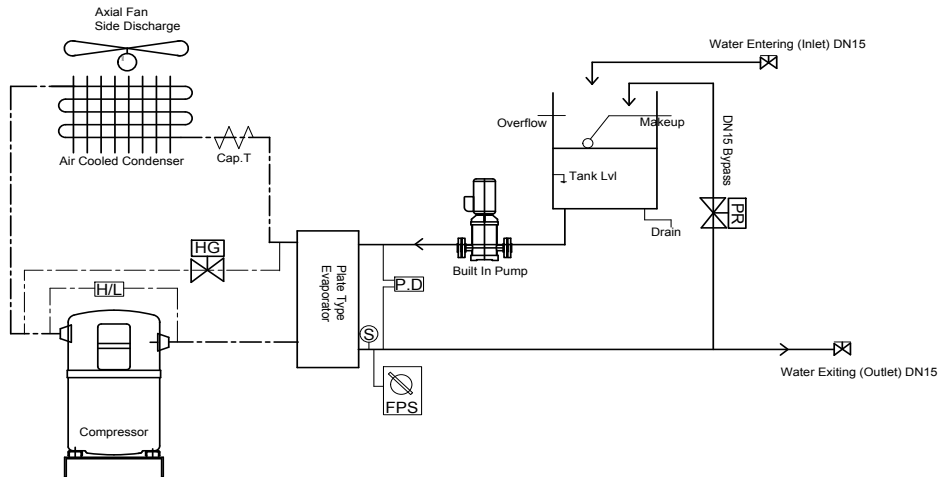





## Schematic Drawing

Applicable for : SAE-AC1, SAE-AC2



 Refrigerant High / Low Pressure Switch  
 Hot Gas Bypass Solenoid Valve  
 Capillary Tube

 Freeze Point Sensor  
 Water Temperature Sensor (Digital)  
 Water Isolation Valve  
 Water Over Pressure Relief Valve  
 Flow Switch ( Pressure Differential )

 Refrigerant Circuit  
 Water Circuit

## Hydraulic Performance

Applicable for : SAE-AC1, SAE-AC2

SAE WP 2-50

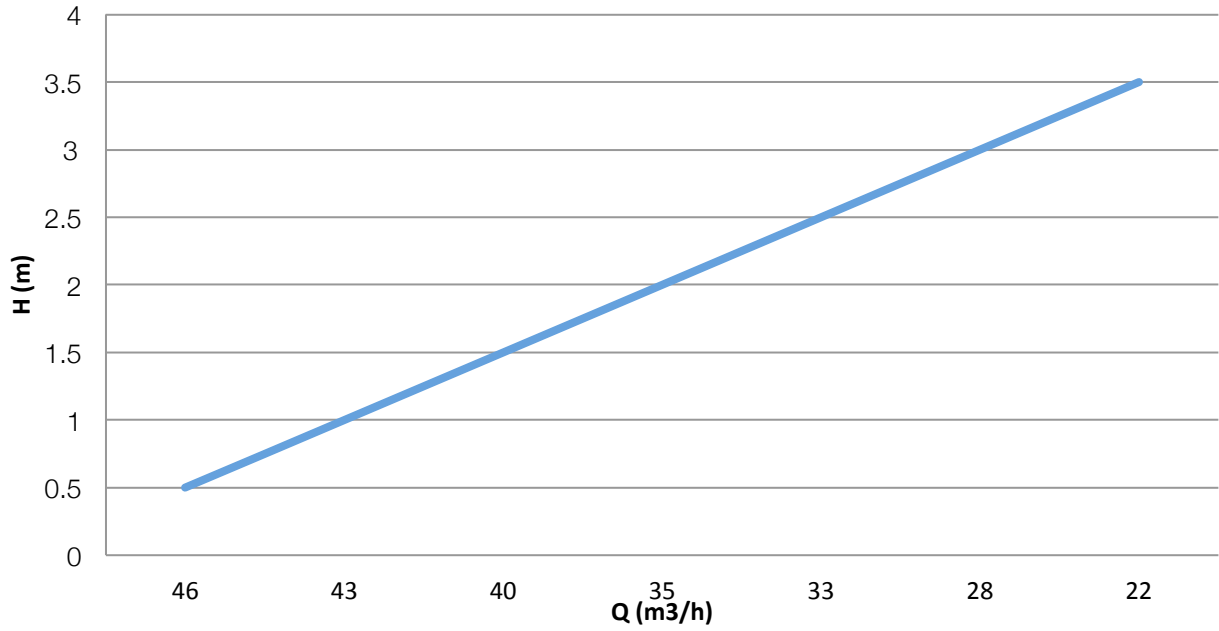

### SAE WP 2-50

0.55 KW / 3.65 A

Q (m³/h)	0.5	1.0	1.5	2.0	2.5	3.0	3.5
H (m)	46	43	40	35	33	28	22

## Water Leaving Correction

Applicable for : SAE-AC1

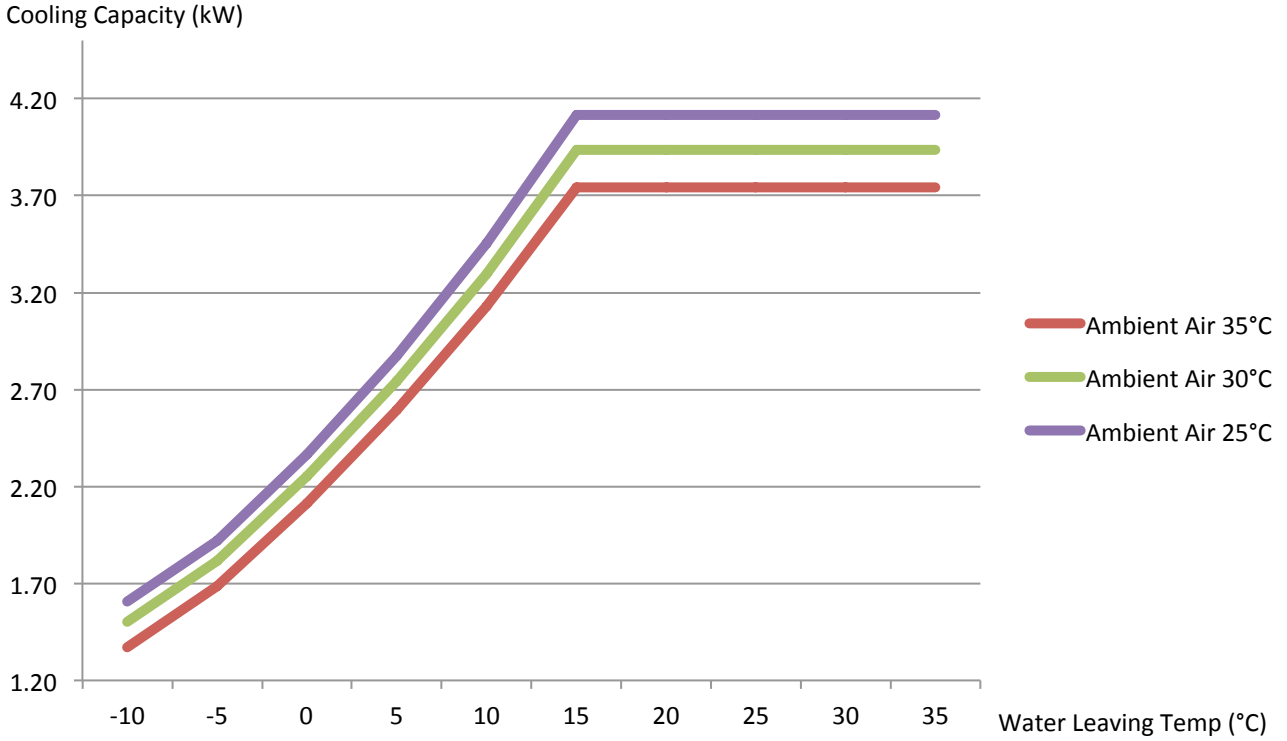

		Ambient Entering Air Temperature		
		35°C	30°C	25°C
SAE-AC1	LWT (°C)			
	-10	1.37	1.50	1.61
	-5	1.69	1.82	1.92
	0	2.12	2.25	2.37
	5	2.60	2.74	2.88
	7	2.80	2.96	3.10
	10	3.13	3.30	3.46
	15	3.74	3.94	4.12
	20	3.74	3.94	4.12
	25	3.74	3.94	4.12
	30	3.74	3.94	4.12
35	3.74	3.94	4.12	



# NOTES :

---

## Shelton (S) Pte Ltd

### Contact Us

Phone +65-6745 5553  
Fax +65-6741 6038  
Address 5A East Point Terrace, Kaki Bukit Road 3  
Singapore 417826  
Website [www.shelton.com.sg](http://www.shelton.com.sg)

